

HOSTILE

A Gritty Sci-Fi RPG

A WEAPON CATALOG

Weapon Illustrations: Ian Stead

Design & Layout : Peter Kreft

ASA Taurus Auto [7.65mm]

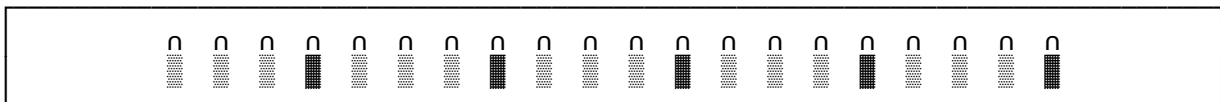
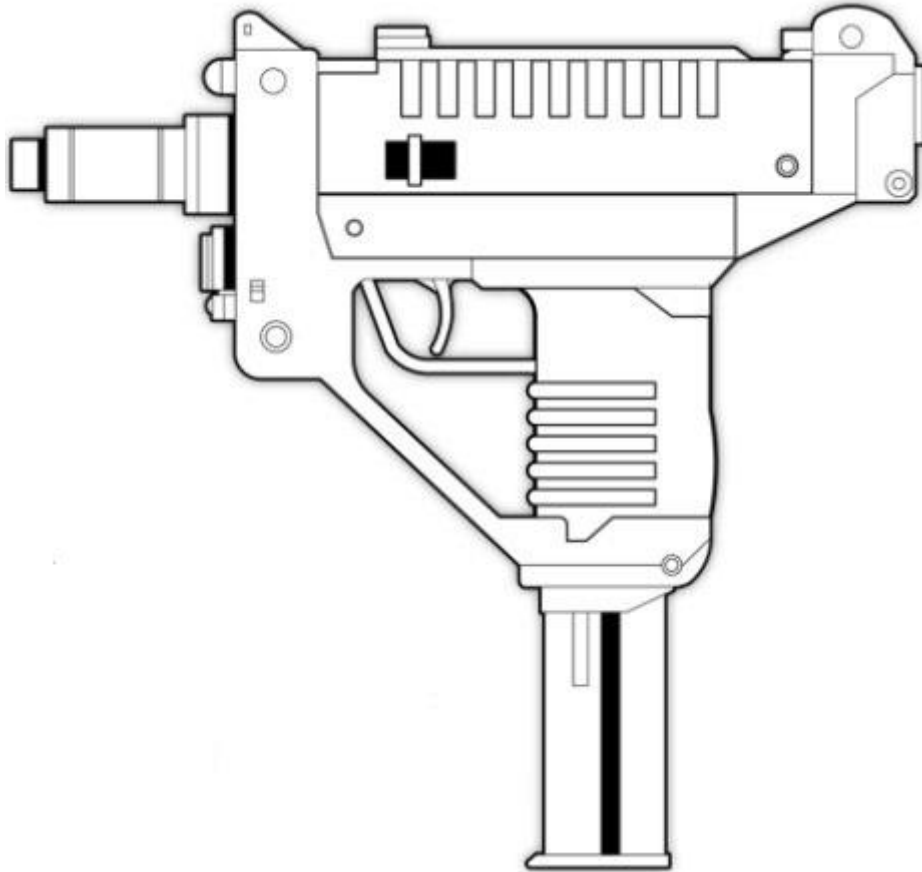

1.2 kg, Ammo .2 kg, 24 cm, Recoil 5, 7.65mm SR Browning (7.65x17) x 20								
ROF	DAM/R	1.5 m	3 m	12 m	50 m	250 m	500 m	5000 m
x 1	2D	10+	8+	8+	10+	12+	-	-
x 4	3D	9+	7+	7+	9+	11+	-	-
x 10	4D	8+	6+	6+	8+	10+	-	-

Firing a light-weight 7.65x17 Browning round with fairly low recoil, the ASA Taurus is capable - not just of 4-round bursts - but of sustained 10-round bursts. This advantage has seen the gun accepted by many police and security forces.

Noricum M44 Revolver [.44 Mag]

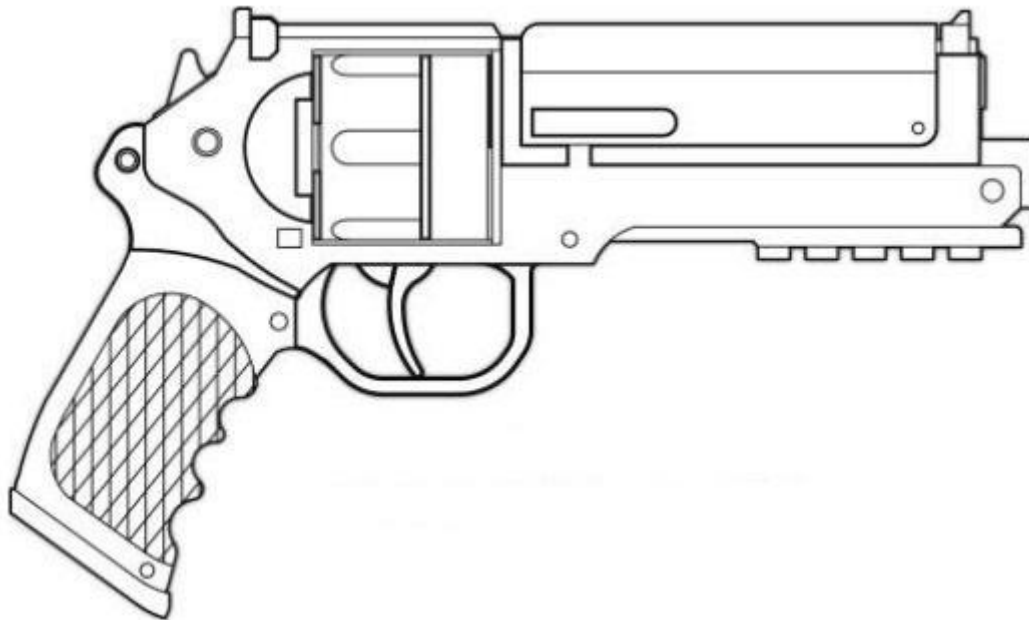

n	n	n	n	n	n	n	n
---	---	---	---	---	---	---	---

1.25 kg, Ammo .12 kg, 29 cm, Recoil 9, .44 Mag (10.9/33) x 6								
ROF	DAM/R	1.5 m	3 m	12 m	50 m	250 m	500 m	5000 m
1T AIM	LASER	8+	6+	6+	8+	10+	-	-
x 1	2D+2	10+	8+	8+	10+	12+	-	-

The Model 44 may look retro, but it is a cutting edge design. Yes, it is a revolver, but it is incredibly reliable and a misfire can be ignored with another pull of the trigger. The Model 44 fires a .44 Magnum round, one of the biggest of the handgun calibers. It features custom amber grips and an in-built red-dot laser sight and rangefinder. An LED on top of the frame provides range indication through color change.

Stern Weapons VP90 [10mm Corta]

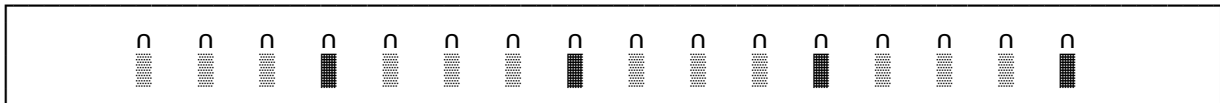

.8 kg, Ammo .16 kg, 20 cm, Recoil 8, 10mm Corta (10x22) x 16								
ROF	DAM/R	1.5 m	3 m	12 m	50 m	250 m	500 m	5000 m
x 1	2D+1	10+	8+	8+	10+	12+	-	-
x 4	3D+1	9+	7+	7+	9+	11+	-	-

The VP90 is a reliable 10mm machine pistol that has been redesigned and re-engineered many times over the past fifty years, but the design is a strong one and its reliability and accuracy have never been bettered. Used as a US Marine sidearm, as well as a close protection firearm for security troops throughout humanexplored space. It features a double column magazine (to cram in 16 x 22mm Corta bullets) and a high-impact plastic receiver.

Williams Auto Redhawk Model 4 [10mm Corta]

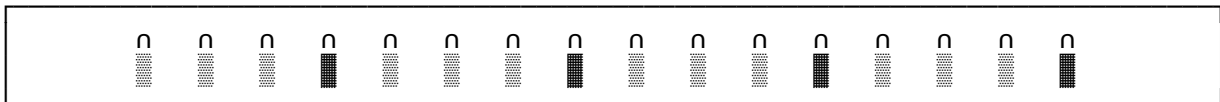
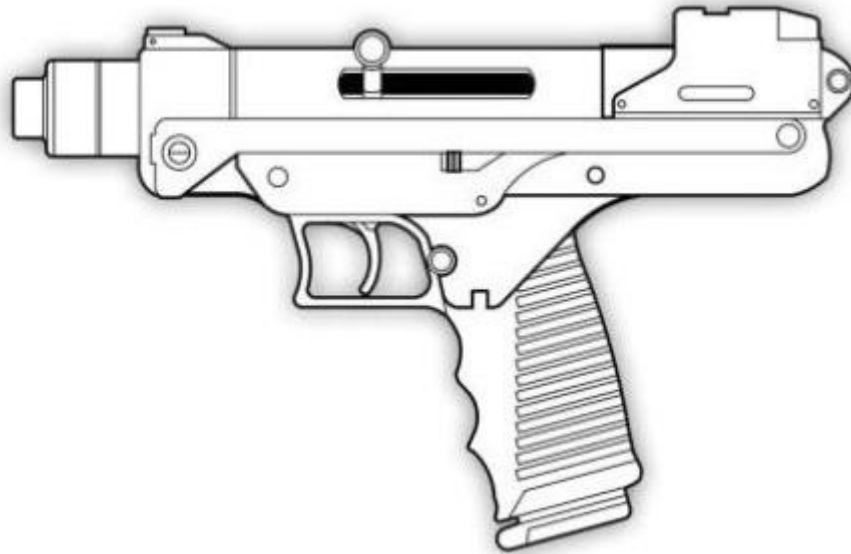

.74 kg, Ammo .16 kg, 19 cm, Recoil 7, 10mm Corta (10x22) x 16								
ROF	DAM/R	1.5 m	3 m	12 m	50 m	250 m	500 m	5000 m
x 1	2D+1	10+	8+	8+	10+	12+	-	-
x 4	3D+1	9+	7+	7+	9+	11+	-	-

The Williams Auto Redhawk Model 4 is one of the most popular auto pistols in use today. Capable of single-shot, for more accurate fire, it also has a burst-fire option. The 10x22m Corta rounds have a lethality that is appreciated by security forces and police units across human space, but the round is still just about manageable in burst mode. Of course, auto fire in a weapon this size requires some skill - a two-handed hold on the weapon is recommended by Williams Arms.

Williams Auto Redhawk Model 5 [10mm Corta]

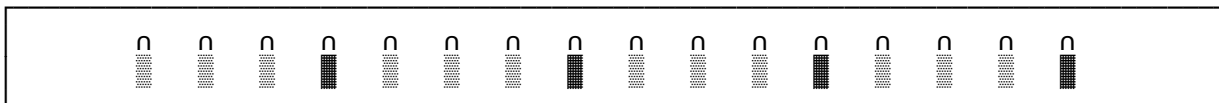

.75 kg, Ammo .16 kg, 20 cm, Recoil 6, 10mm Corta (10x22) x 16								
ROF	DAM/R	1.5 m	3 m	12 m	50 m	250 m	500 m	5000 m
x 1	2D+1	10+	8+	8+	10+	12+	-	-
x 4	3D+1	9+	7+	7+	9+	11+	-	-

The Williams Auto Redhawk Model 5 is one of the most popular auto pistols in use today. Capable of single-shot, for more accurate fire, it also has a burst-fire option. The 10x22m Corta rounds have a lethality that is appreciated by security forces and police units across human space, but the round is still just about manageable in burst mode. Of course, auto fire in a weapon this size requires some skill - a two-handed hold on the weapon is recommended by Williams Arms. The Model 5 was designed to improve the otherwise lacklustre accuracy of the Model 4. It features a 2cm extension to the barrel and a revised front sight in the form of a front post in a hooded ring.

Avtomat Kaliningrad AKZ-4 [6.50mm]

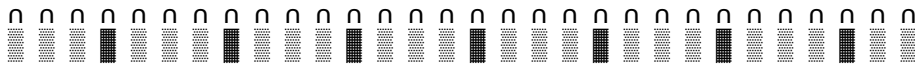
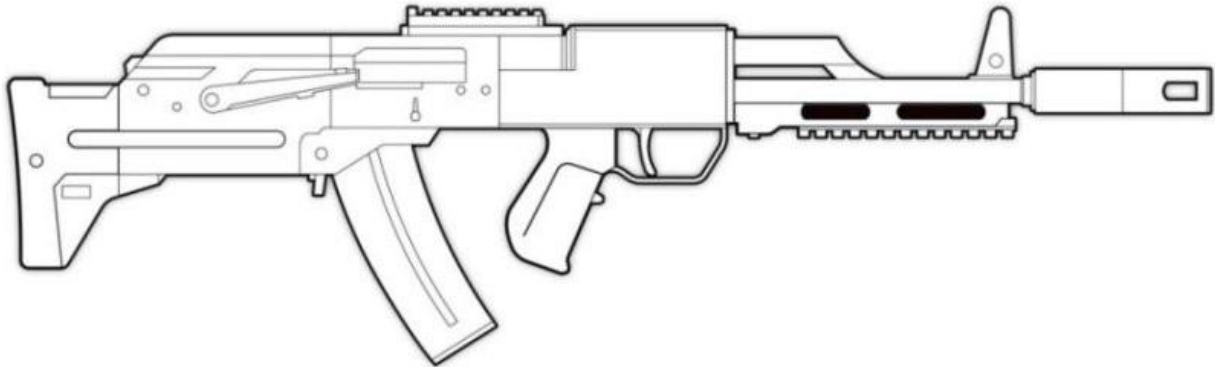

3.6 kg, Ammo .6 kg, 78 cm, Recoil 6, 6.50mm (6.50x50) x 30

ROF	DAM/R	1.5 m	3 m	12 m	50 m	250 m	500 m	5000 m
x 1	3D	10+	8+	8+	8+	10+	12+	-
x 4	4D	9+	7+	7+	7+	9+	11+	-
x 10	5D	8+	6+	6+	6+	8+	10+	12+

The Kalashnikov family of military rifles have a long pedigree and have been produced by various manufacturers over the years; from the AK-47, the AKM, the AK-74, the AK-100 , 200 and 300 series, and finally the AKZs. The AKZ-4 is a rugged bullpup assault rifle fitted with a magazine holding 30 x 6.50mm rifle rounds. A large selector allows single-shot, 4 round or 10 round bursts. In essence it is the same light-weight polymer rifle as the AK-340, but now chambered for the ubiquitous 6.50mm military rifle round. Rails for scopes and other attachments are fitted on the underside of the barrel and on top of the receiver.

Maverick M24A1 ACR [8.85mmCL]

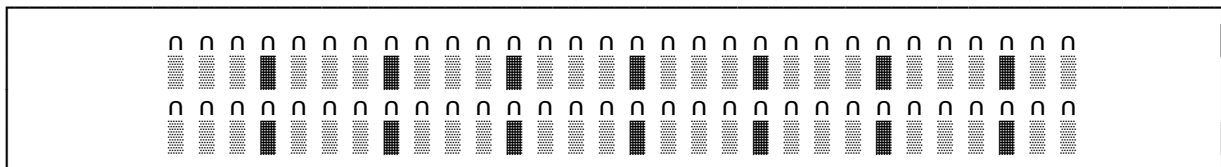
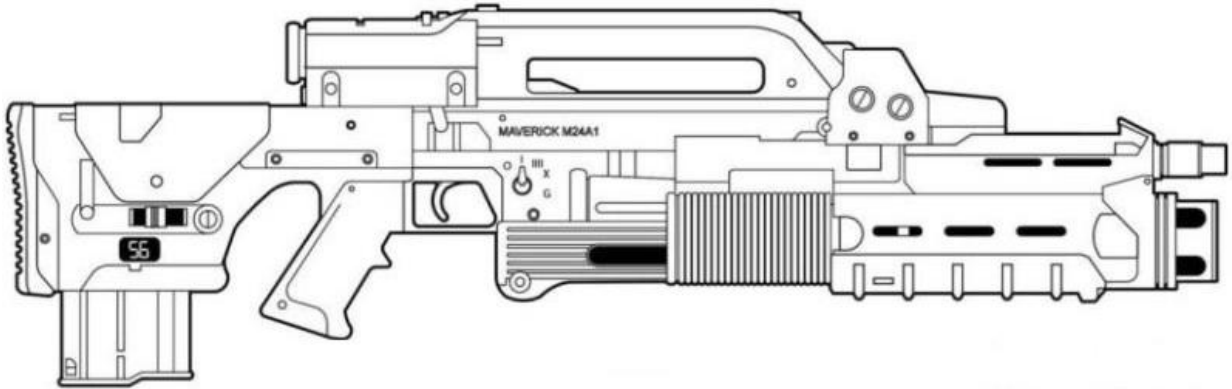

4.6 kg, Ammo .5 kg, 80 cm, Recoil 7, 8.85mm FSDS Caseless x 60								
ROF	DAM/R	1.5 m	3 m	12 m	50 m	250 m	500 m	5000 m
1T AIM	SCOPE	8+	6+	6+	6+	8+	10+	12+
x 1	3D+2	10+	8+	8+	8+	10+	12+	-
x 4	4D+2	9+	7+	7+	7+	9+	11+	-
x 10	5D+2	8+	6+	6+	6+	8+	10+	12+
30 mm GL	HEAP	5D6	3D6	1D6				

The M24A1 represents the cutting edge of American military firepower. It is an advanced assault rifle firing high-velocity 8.85mm FSDS discarding sabot bullets at 1200 meters per second. Sighting is done with an integral AN/PVS-29 telescopic sight (4x magnification), which features hybrid IR and light-intensification imaging. Each caseless 5.60mm round is embedded deep within a polymer casing that is packed with consolidated propellant - this is ignited by the M24A1's electrical firing mechanism. An M340 30mm grenade launcher is mounted under the barrel and it utilises a high-low recoil-minimising propulsion system. This launcher holds a total of four grenades and a round is loaded into the breech ready for launching by cycling a pump-action grip.

Maverick M24A3 Carbine [8.85mmCL]

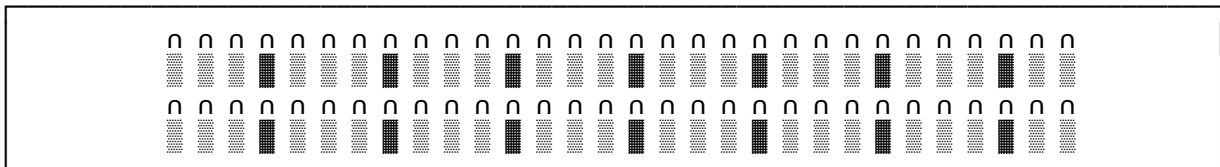
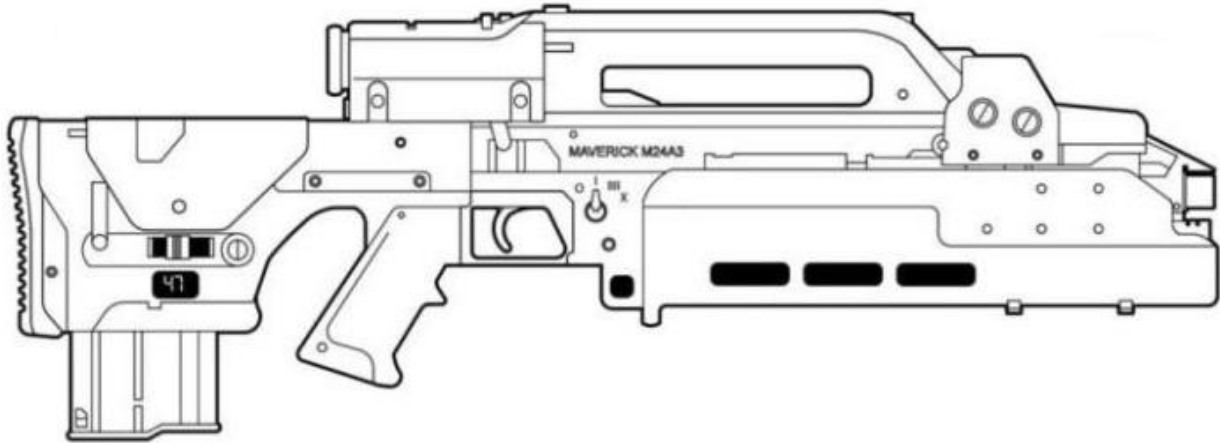

3.4 kg, Ammo .5 kg, 74 cm, Recoil 8, 8.85mm FSDS Caseless x 60								
ROF	DAM/R	1.5 m	3 m	12 m	50 m	250 m	500 m	5000 m
1T AIM	SCOPE	8+	6+	6+	6+	8+	10+	12+
x 1	3D+1	10+	8+	8+	8+	10+	12+	-
x 4	4D+1	9+	7+	7+	7+	9+	11+	-
x 10	5D+1	8+	6+	6+	6+	8+	10+	12+

The M24A3 is a shortened carbine version of the standard M24A1 advanced combat rifle. It is an advanced carbine firing high-velocity 8.85mm FSDS discarding sabot bullets at 1200 meters per second. It uses an annular gas piston located around the barrel and a vertically moving bolt, making it possible to minimise the length of the receiver group and have a magazine located at the extreme rear of the weapon. Sighting is done with an integral AN/PVS-29 telescopic sight (4x magnification), which features hybrid IR and light-intensification imaging. This version is used by jump-jet and armoured vehicle crews who appreciate its compact design, as well as by police forces, private military contractors and rear-echelon troops (signallers, drivers and mine-clearance troops, etc.).

Singapore Arms SA66 [6.50mm]

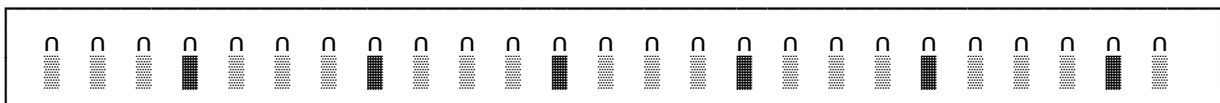
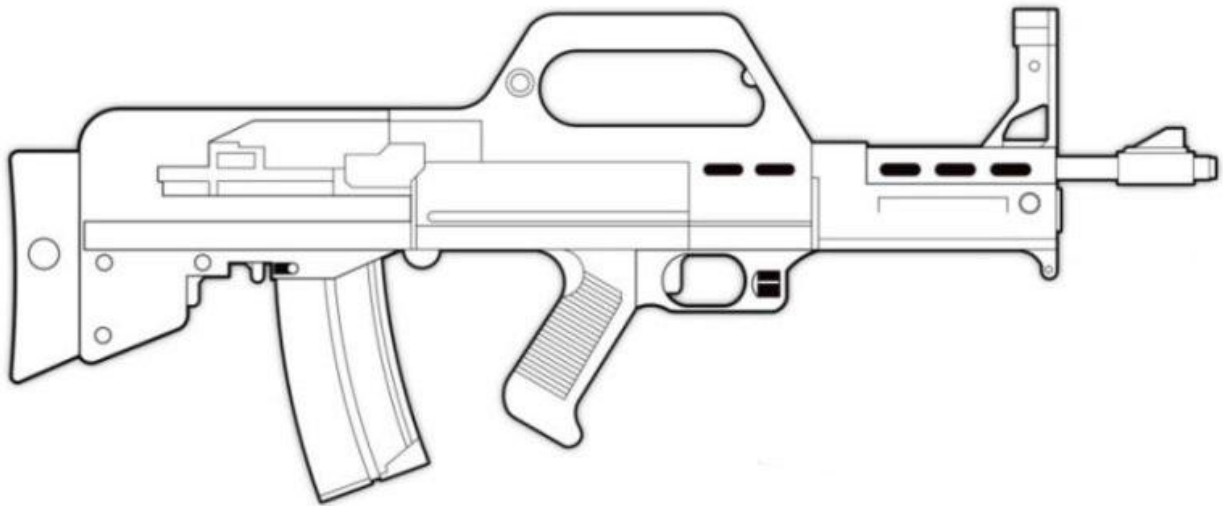

3.3 kg, Ammo .5 kg, 75 cm, Recoil 7, 6.50mm (6.50x50) x 25								
ROF	DAM/R	1.5 m	3 m	12 m	50 m	250 m	500 m	5000 m
x 1	3D	10+	8+	8+	8+	10+	12+	-
x 4	4D	9+	7+	7+	7+	9+	11+	-
x 10	5D	8+	6+	6+	6+	8+	10+	12+

The Singapore Arms SA66 is a light-weight assault rifle firing the standard military 6.50mm rifle round. The gun is sold fairly cheaply and found in service with a host of security forces and the armed forces of small nations. It is particularly popular with colonial forces and by colonists out on frontier worlds, who need a simple, light-weight but effective rifle to hand. It incorporates a carrying handle and a simple vacuformed clamshell body. Perhaps contributing to the weapon's popularity is its light weight, reliability and its ease of use. On the downside, the recoil is quite harsh making the gun a little hard to keep on target.

Stern Universal T51 [7.78mm]

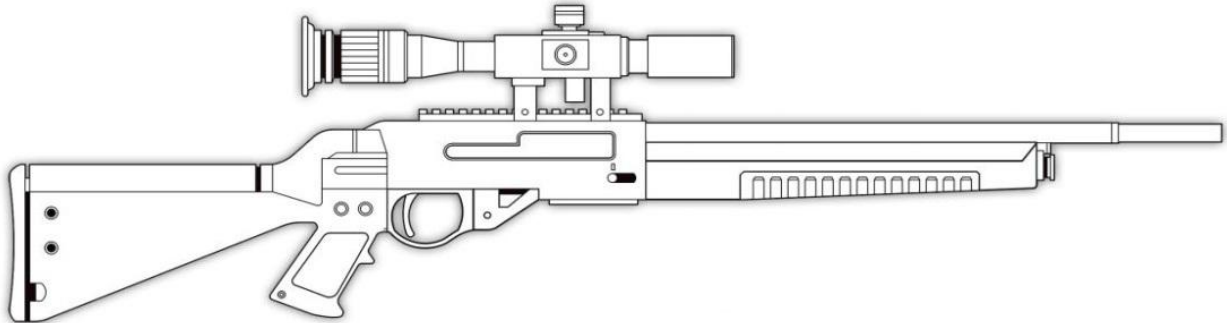

n	n	n	n	n	n	n	n
---	---	---	---	---	---	---	---

3.4 kg, Ammo .4 kg, 99 cm, Recoil 6, 7.78mm (7.78x52) x 8								
ROF	DAM/R	1.5 m	3 m	12 m	50 m	250 m	500 m	5000 m
1T AIM	SCOPE	10+	8+	6+	6+	6+	8+	10+
x 1	3D+2	12+	10+	8+	8+	8+	10+	12+

This semi-automatic rifle fires one round for every pull of the trigger. It fires a powerful 7.78 x 52 bullet with some accuracy out to 1200m. The Universal T51 is popular with security marksmen, woodsmen and colonists who need a rifle for both survival and hunting. A snug, form-fitting 8 shot magazine is inserted forward of the trigger assembly. Integral optical sights come as standard, but they can be removed. In fact, the entire rifle can be easily disassembled and stored within a purpose-made impact-resistant carry-box. The intention was for the gun to remain in a pristine condition when not used during activities in the colonies (bouncing around in ATVs or thrown in the back of a temporary pressurized base). This ability to break down the T51 has seen it gain some use with hitmen out on the frontier.

Voroncovo M33 Coilgun [12mm HVADS]

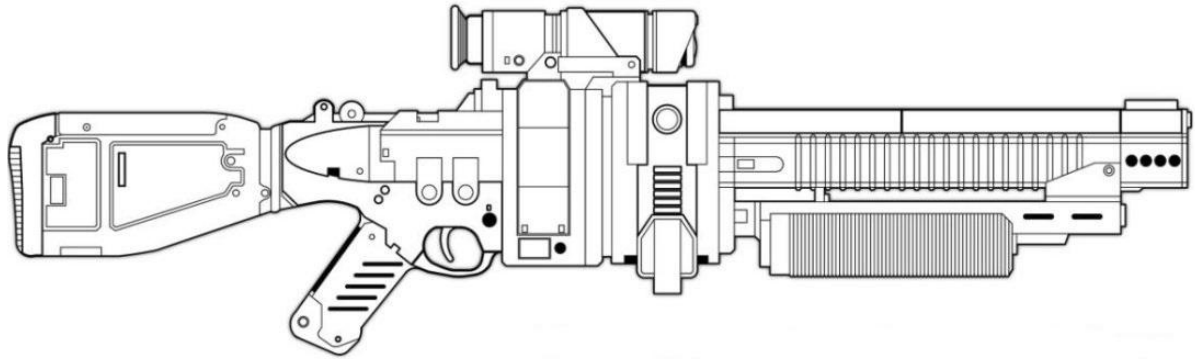

5.5 kg, Ammo .6 kg, 103 cm, Recoil 8, 12mm HVADS (12x67) x 10								
ROF	DAM/R	1.5 m	3 m	12 m	50 m	250 m	500 m	5000 m
1T AIM	SC+LAS	9+	7+	5+	5+	5+	7+	9+
x 1	4D+2	12+	10+	8+	8+	8+	10+	12+

The Voroncovo corporation has introduced a new type of magnetic coil technology, bringing magnetic acceleration to the infantryman's battlefield. The coilgun is a large caliber sniper and anti-material rifle that accelerates ferrous rounds through electromagnetic coils that are powered by a high-energy liquid-metallic suspension battery. Discarding sabot rounds are loaded into the gun in a 20 round magazine to the rear of the trigger assembly. Each is a 12mm HVADS (High Velocity Accelerated Discarding Sabot) that is given imparted spin using bias in the magnetic field. After leaving the barrel, the sabots fall away to reveal the 9.46mm teardrop-shaped bullet that consists of hardened steel, surrounded by a softer copper jacket with a hollow-point tip. The combination of high-velocity (upwards of 1400 meters per second), hollow-point tip and dense core, gives the round superb stopping power as well as an effective armorpiercing capability. The real limit on coil gun technology is the dependence on power and so the M33 is a precision sniper rifle, a weapon that will not be firing hundreds of rounds a minute.

Zenith M1000 30MW Combat Laser

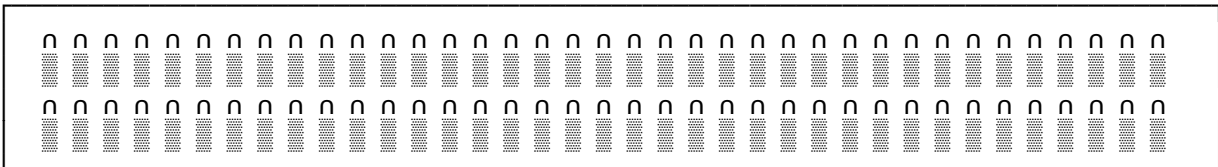
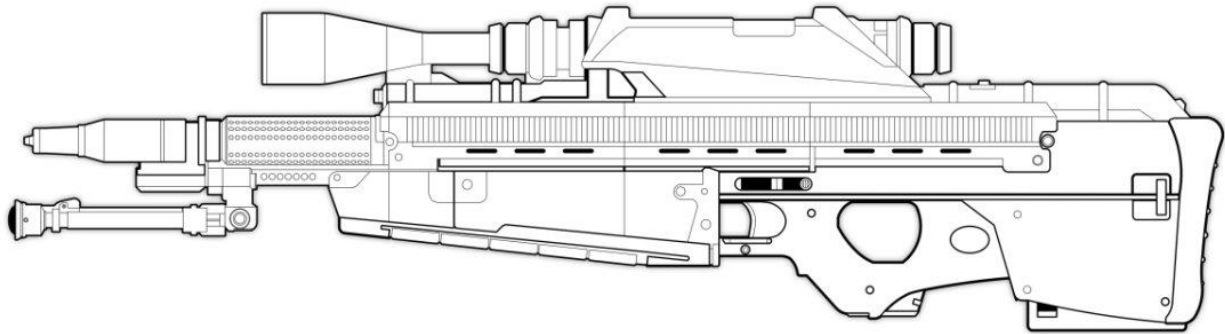

4.2 kg, Ammo 1 kg, 80 cm, Recoil 0, LASER x 75								
ROF	DAM/R	1.5 m	3 m	12 m	50 m	250 m	500 m	5000 m
1T AIM	SC+LAS	9+	7+	5+	5+	5+	7+	9+
x 1	4D+2	12+	10+	8+	8+	8+	10+	12+

Zenith is renowned for its optics and range of laser weapons - the M1000 is the lightest and most portable of all of the company's firearms. On a trigger pull, the liquid metallic suspension battery charges a fast-discharge generator which briefly stores then releases that energy as a pulse. The high energy, short-duration beam causes instantaneous and extreme temperature change in a target's surface causing vaporization and thermal shock. The rifle is used for precision sniper attacks at extremely long range, and to target this long range weapon Zenith have fitted a sophisticated, gyrostabilised electronic sighting system. The battery slots into the underside of the stock. A bipod is fitted.

Williams Model 9 Stun Gun

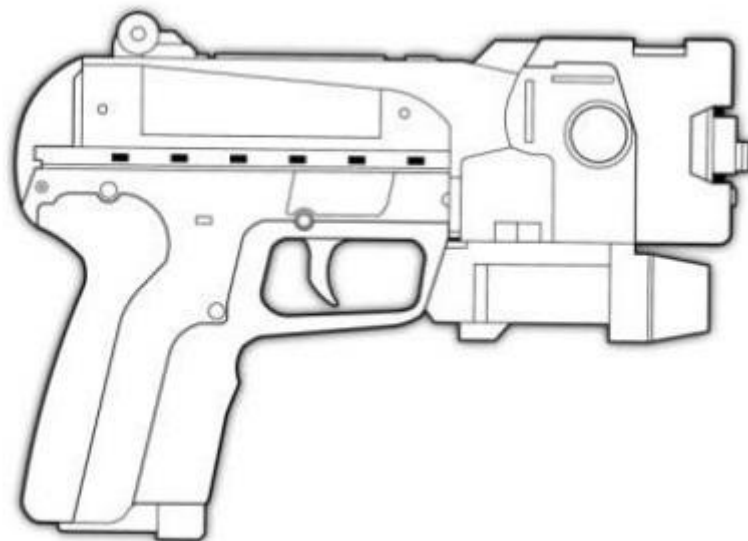

n ▬▬▬	n ▬▬▬	n ▬▬▬	n ▬▬▬	n ▬▬▬
----------	----------	----------	----------	----------

.5 kg, Ammo .1 kg, 18 cm, Recoil 6, Special x 5								
ROF	DAM/R	1.5 m	3 m	12 m	50 m	250 m	500 m	5000 m
x 1	2D	10+	8+	8+	10+	12+	-	-

Twenty-third century stun guns use focussed sonic waves to disorientate and hopefully incapacitate their victims. They are a non-lethal alternative to handguns, easy to handle with no recoil, but useful only at short range. When hit by the Stun Gun, a target makes an End roll with a DM penalty equal to the damage rolled. Subtract armor from this damage. If failed, the target is unconscious for 1D6 minutes. If successful, then the target takes a -1 penalty to his actions for 1D6 minutes, but is otherwise free to act.

ASA Hoplite Combat Shotgun [12 gauge]

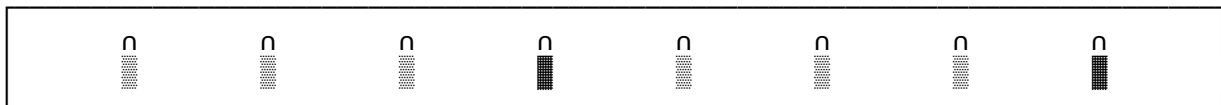

3.8 kg, Ammo .6 kg, 81 cm, Recoil 6, 12 gauge x 8								
ROF	DAM/R	1.5 m	3 m	12 m	50 m	250 m	500 m	5000 m
x 1	4D	10+	8+	10+	10+	12+	-	-
x 4	5D	9+	7+	9+	9+	11+	-	-

The Hoplite is touted as a fully automatic shotgun, and it is capable of firing 4 round bursts, but such short-range, indiscriminate firepower has little use other than in gang warfare. More-often, the weapon is purchased for its handy bullpup layout, smooth semi-auto (one shot per pull of the trigger) action and accessory rail above the barrel for laser sights, torches etc.

Noricum 37 Stakeout [12 gauge]

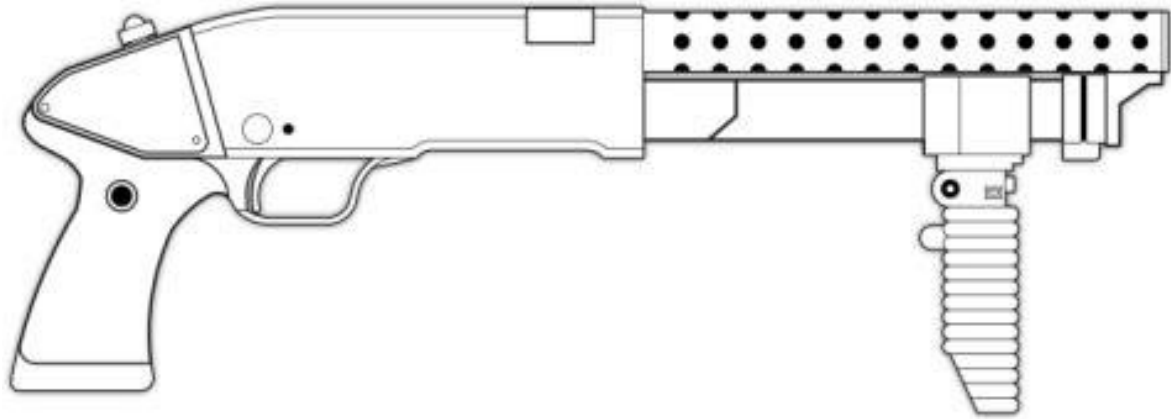

n	n	n	n
---	---	---	---

3 kg, Ammo .4 kg, 76 cm, Recoil 9, 12 gauge x 4								
ROF	DAM/R	1.5 m	3 m	12 m	50 m	250 m	500 m	5000 m
x 1	4D	10+	8+	10+	10+	12+	-	-

The Noricum 37 is based on a 1946 design; it has since proven itself for more than two centuries as a workhorse shotgun of worldwide police forces, security companies and military units. It is in essence, the bare bones of what a shotgun needs to be, cutting everything down in size to create a very handy and easily used weapon, in buildings, streets, jungles, starship corridors and mining installations. No wonder it is a favourite of the US Colonial Marshals. The gun is pump-action, and includes a folding stock. It is capable of being concealed under long, loose clothing. A tubular magazine inserted beneath the barrel holds 4 shells.

Stern Weapons 2000 Shotgun [12 gauge]

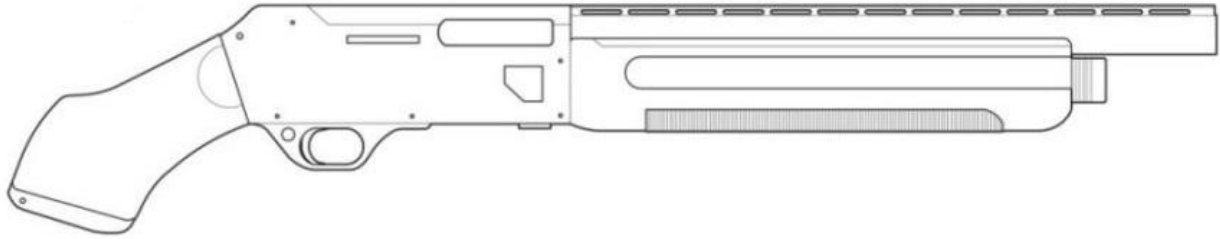

n	n	n	n	n
---	---	---	---	---

3 kg, Ammo .4 kg, 77 cm, Recoil 8, 12 gauge x 5								
ROF	DAM/R	1.5 m	3 m	12 m	50 m	250 m	500 m	5000 m
x 1	4D	10+	8+	10+	10+	12+	-	-

Stern has been producing shotguns for over two hundred years, and the 2000 is a design that has changed little in that time. It is semiautomatic (one shot per pull of the trigger), rather than pump-action, and is sold for use on colony outposts and starships in a 'personal defense' layout [the stock is removed and the barrel shortened drastically]. A tubular magazine inserted beneath the barrel holds 5 shells.

ASA M3 Hydra IMAG [9mm HE]

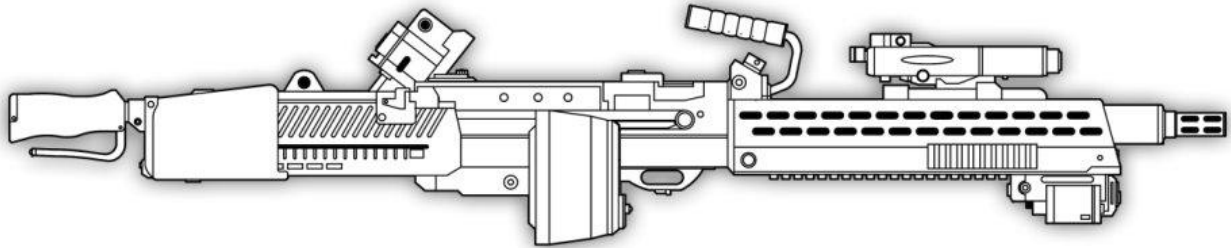

16 kg, Ammo 2 kg, 122 cm, Recoil 7, 9mm HE x 250								
ROF	3D+4	1.5 m	3 m	12 m	50 m	250 m	500 m	5000 m
x 4	4D+4	10+	8+	6+	6+	6+	8+	10+
x 10	5D+4	9+	7+	5+	5+	5+	7+	9+

A new concept in squad machineguns, the Intelligent Machinegun-Auto Guiding (IMAG) is a gimbal-mounted light machinegun attached to a steady-mount and operator's harness. Tracking is via both motion tracker and infra-red sensor mounted above and below the barrel, these send images with targeting overlays to the user's smart goggles that are connected to the gun via cable and jack. The gun can aim and track independently or be nudged to acquire another target appearing on the smart-goggle display. It cannot fire on its own. Only the operator can do this, with a pull of the trigger. Supplied by an ammunition drum holding 250 rounds of 9x28mm caseless, the IMAG Hydra is used to provide suppressive fire, to deal with armoured troops, equipment, and with soft-skinned vehicles. It does this with a slightly larger and more powerful round than used in the M24 series of rifles. The 9x28mm round is designated as HE (high explosive), giving the squad a real punch.

Maverick Defense M68 Light Machine Gun [8.85mmCL]

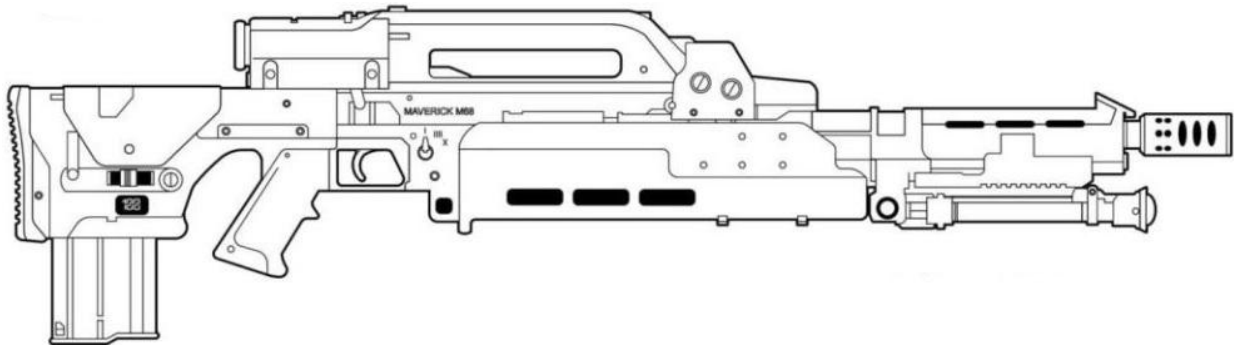

6.6 kg, Ammo .88 kg, 90 cm, Recoil 6, 8.85mmCL x 100								
ROF	DAM/R	1.5 m	3 m	12 m	50 m	250 m	500 m	5000 m
1T AIM	SCOPE	10+	8+	6+	6+	6+	8+	10+
x 1	3D+2	12+	10+	8+	8+	8+	10+	12+
x 4	4D+2	11+	9+	7+	7+	7+	9+	11+
x 10	5D+2	10+	8+	6+	6+	6+	8+	10+

The M68 is a light machinegun variant of the standard M24A1 advanced combat rifle. In order to fulfil its role as a squad support weapon, the M68 is fitted with a longer and heavier barrel that can cope with sustained burst fire without over-heating. In addition, the grenade launcher has been dropped in favour of a folding bipod, used to support the weapon as it provides covering fire for the rest of the squad during fire and movement operations. Like the M24A1 the M68 fires high-velocity 8.85mm FSDS discarding sabot bullets at 1200 meters per second. It uses an annular gas piston located around the barrel and a vertically moving bolt, making it possible to minimise the length of the receiver group and have a magazine located at the extreme rear of the weapon. Sighting is done with an integral AN/PVS-29 telescopic sight (4x magnification), which features hybrid IR and lightintensification imaging.

Steyr-Brandt StG 340 [8.85mmCL]

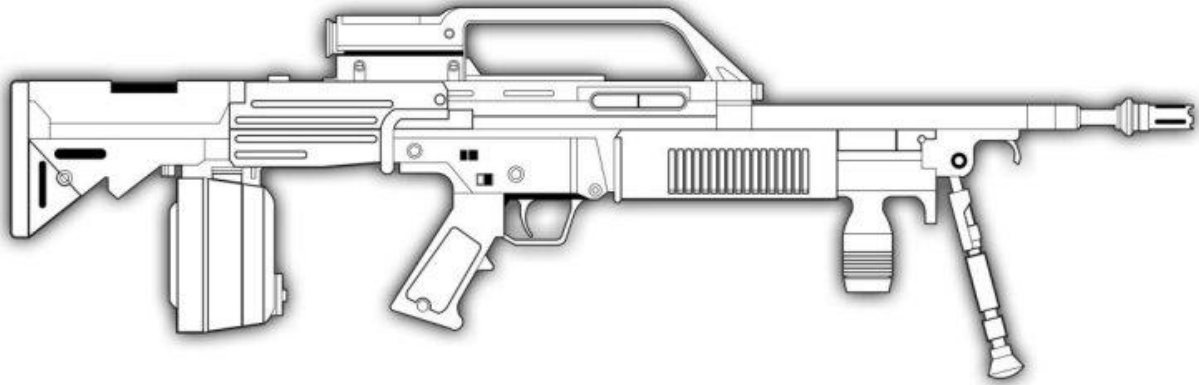

6.2 kg, Ammo .88 kg, 86 cm, Recoil 5, 8.85mmCL x 100								
ROF	DAM/R	1.5 m	3 m	12 m	50 m	250 m	500 m	5000 m
x 1	3D+3	12+	10+	8+	8+	8+	10+	12+
x 4	4D+3	11+	9+	7+	7+	7+	9+	11+
x 10	5D+3	10+	8+	6+	6+	6+	8+	10+

The Steyr-Brandt StG 340 is a heavy assault rifle used either as a light machinegun, or with the bipod removed and the ammo hopper swapped for a 30 round box magazine, as an assault rifle. Quick conversion to a rifle lightens the gun to 4kg. The StG 340 fires the modern high-velocity 8.85mm discarding sabot bullet at 1200 meters per second. Each caseless 5.60mm sabot round is embedded deep within a polymer casing (of 8.85mm calibre) that is packed with consolidated propellant - this is ignited by the Steyr's electrical firing mechanism. The 340 is used by several armies, including Germany, Great Britain and Brazil.